



# INTERNATIONAL PRECISION SHOOTING RULES



	<p><b>INTERNATIONAL RULES</b></p> <p><b>DISCIPLINE:</b> <b>PRECISION SHOOTING</b></p>	<p>CBI-R001.1 Rev. 1 Approved on 25 March 2026 Page 2 / 31</p>
---	---	--

**Applicability:**

<b>Competizioni</b>
WORLD CHAMPIONSHIPS
CONTINENTAL CHAMPIONSHIPS
INTERNATIONAL EVENTS

*CBI documents release by signature.*

NAME	TITLE	SIGNATURE	DATE	ACTION
Lopparelli R.	International Technical Committee		30/01/2026	Prepared by
Lopparelli R.	Chairman International Technical Committee		27/02/2026	Agreed with
Dott.Prof. M. Turkmen	President Board CBI		25/03/2026	Approved

**Revision History**

REVISION	DATE	CHANGE DESCRIPTION
-	01/01/2021	First Release
1	30/01/2026	General Revision



### Summary

1	<b>NORMATIVE REFERENCES .....</b>	<b>4</b>
2	<b>SCOPE .....</b>	<b>5</b>
3	<b>TERMS AND DEFINITIONS .....</b>	<b>5</b>
4	<b>GAME PLAYING AREA (COURT) .....</b>	<b>7</b>
5	<b>BOWLS &amp; OFFICIAL GAME KIT OF THE DISCIPLINE.....</b>	<b>7</b>
6	<b>GAME FORMATS AND SCORING .....</b>	<b>10</b>
7	<b>PROCEDURE FOR THE EXECUTION OF THE MATCH .....</b>	<b>15</b>
8	<b>SUMMARY TABLE SCORE AND SCORE REGISTRATION SHEET.....</b>	<b>20</b>
9	<b>QUALIFICATION AND RANKING PROCEDURE.....</b>	<b>23</b>
10	<b>ALTERNATIVE QUALIFICATION PROCEDURE AFTER THE 2 MATCHES OF THE 1ST ROUND.....</b>	<b>29</b>
11	<b>DECISION PROCEDURE .....</b>	<b>30</b>
12	<b>SPECIFIC SITUATIONS .....</b>	<b>30</b>
13	<b>CRITERIA AND PROCEDURES FOR THE RATIFICATION OF WORLD OR CONTINENTAL RECORDS .....</b>	<b>31</b>



## 1 NORMATIVE REFERENCES

The following document contains provisions and standards which, through reference in this text, constitute requirements applicable to this regulation. When the documents cited are updated, the most recent applicable version shall apply.

The regulatory framework of the **\*\*Confederazione Boccistica Internazionale (CBI)** is aligned with the principles and standards established by the following organizations and instruments:

- The governance principles and integrity standards of the International Olympic Committee (IOC)
- The inclusion and accessibility standards of the International Paralympic Committee (IPC)
- The World Anti-Doping Agency (WADA) and the World Anti-Doping Code
- The UNESCO International Convention against Doping in Sport
- UNESCO's 2030 Agenda for Sustainable Development
- The principles of governance and Sport for All promoted by TAFISA
- The regulatory framework for sport of the World Bocce Playing Body Federation (WPBF), where applicable.

In addition, these regulations must be interpreted in conjunction with the following internal CBI documents, where applicable:

- CBI Statutes
- CBI Code of Ethics
- CBI Clean Sport Regulations
- CBI Safe Sport and Safeguarding Policies
- CBI Technical Standards and Terminology Documents.

In the event of a conflict between the documents, the CBI Statutes and these regulations shall prevail in matters relating to the discipline of precision shooting.

Any request for information or authorizations shall be addressed to: CBI - Confederazione Boccistica Internazionale Via Emilio Bossi 50 - CH 6830 CHIASSO Email: [info@cbi-prv.org](mailto:info@cbi-prv.org)

Note: Translations into other languages are encouraged and will be produced and distributed to facilitate the understanding and application of the content. It is understood that the English and Italian versions remain the only valid references for any interpretation and/or rules.

© Copyright-Protected Document. All rights reserved. Unless otherwise specified, no part of the content of this document may be used in any form or by any means, including photocopying or microfilming, without the written authorization of the CBI Executive Committee.



**Note:**

1. The original author of this document is Dino Amadò (Chairman of the Technical Commission) during the year 2021, later supported by other CBI experts in various areas of competence to complete the configuration within the Technical Commission.
2. The terms and references are based on International Sports Standards and Regulations where not otherwise specified in the CBI terminology documents, with the support of a sports auditing governing body.

## **2 SCOPE**

This document outlines the rules of the “Precision Shooting” discipline and the regulations governing the conduct of the “International Tournament, World and Continental Championship” competitions.

The present document has been drafted to ensure compatibility with international, continental, and national federations operating in accordance with CBI international and continental standards.

This document provides a single, structured, and harmonized reference for Precision Shooting. The update is also necessary in relation to the evolution of the discipline at a competitive level and as a sport for all, across different geographical and cultural areas, as well as its use as an educational and rehabilitative tool, fields in which the specific roles described in Chapter 3 are involved.

## **3 TERMS AND DEFINITIONS**

- **Competition:** An officially sanctioned event organized under the authority of the CBI or its affiliated National or Continental Federations, including international tournaments, continental championships, and world championships.
- **Precision shooting:** The technical discipline of the sport in which athletes attempt to hit predetermined target bowl or pallino according to specific rules, distances, and scoring criteria established in these regulations.
- **Athlete:** a person male or female registered for the championship or event by their national federation or by their affiliated club and authorized to compete in an event recognized by the CBI.



- **Referee Manager:** a person holding a valid CBI International Referee License (according to the latest edition of the official list). He is appointed by the competent authority of the CBI and is responsible for coordinating the refereeing team, resolving interpretations of the rules, and validating the official results of the competition.
- **Referee:** a person holding a valid referee license, Appointed by the organizing authority or the competent CBI body, he is responsible for enforcing the rules of the competition, ensuring fair play, and validating the correct execution of the discipline.
- **Linesman:** a person holding a valid referee license, who supervises the match together with the referee and is responsible for line control.
- **Assistant:** a support person who is not necessarily required to hold a Referee license, and who follows the instructions of the referee or the lineman referee without having any decision-making authority.
- **Technical Delegate:** A representative appointed by the CBI responsible for supervising the correct application of the rules and ensuring that the competition complies with the CBI's technical and organizational standards.
- **Target:** bowl or pallino to be hit
- **Bowl/s obstacle:** bowl or bowls used as obstacle/s to hit the target.
- **Mat :** main element used to position the target and obstacle/s at the various distances defined by the rules; identification code: **CIB-EQP-001-1**.
- **Target or obstacle/s placer:** additional elements placed on the carpet to configure the various targets to be hit and the obstacles for each playing position.
- **Valid Shot:** A shot performed by an athlete that meets the technical and procedural requirements defined in the rules of the discipline
- All other terminology and definitions are the same as those used in the Raffa discipline.

## 4 GAME PLAYING AREA (Court)

The playing area/courts must consist of a Punto-Raffa- Volo type surface approved for use in CBI competitions, according to the dimensions indicated below, and must be bordered by wooden boards or other non-metallic sidewalls with a height of 25 cm and a tolerance of  $\pm 2$  cm. These parameters must be checked before the event. Under no circumstances may these materials violate local safety regulations and/or pose a risk to the health of athletes, referees, or assistants.

The dimensions of the playing area must be within these parameters:

- **Width:** must be between 3.50 and 4.00 m; this measurement may be extended to between 3.50 and 4.50 m, but doing so will exclude the possibility of approving or ratifying any potential World or Continental record
- **Length:** must be  $\geq 22.50$  m

## 5 BOWLS & OFFICIAL GAME KIT OF THE DISCIPLINE

### 5.1 Bowls

- a. The material, color, diameter, and weight of the bowls used by the must be compliant with the standards and requirements in force at the time of the event. Refer to document CBI-R005.0, used for the qualification of products in accordance with international requirements:
  - Diameter: 105.5 / 107.5 mm
  - Weight: 900 / 920  $\pm$  5 g
  - Material: Synthetic and non-toxic resins.

- b. Athletes must use a set of bowls for the competition that complies with and meets the standard requirements indicated above and must checked and formally approved by the Referee responsible for the competition or event or by a designated official.

If the bowls are found are don't comply with the standard requirements, they must be replaced with compliant ones; failure to do so will result in exclusion from the competition.

At World and Continental Championships, if the bolws are found not comply with the standard requirements by the responsible Referee or by a designated official and the athlete does not have a compliant replacement set, the athlete may use the bowls provided free of charge by the LOC (Local Organizing Committee).

## 5.2 Official game kit of the discipline

- a. The official CBI game set, code CBI-EQP-001-0, consists of one white pallino, one white bowl, two red obstacle bowls, and a carpet whose dimensions are indicated below (Table 1), together with the accessories required for positioning the pallino and the bowls (Technical Specification CBI-R004.0). The official CBI game kits are manufactured using materials that do not violate local safety regulations and/or pose any risk to the health of athletes, referees, or assistants.

TABLE 1			
ITEM	IDENTIFICATION CODE	DIMENSIONS	THICKNESS / COLOR
1	CIB-EQP-001-001	100 × 64,5 cm	4 mm
2	CIB-EQP-001-002	*	4 mm
3	CIB-EQP-001-003	*	4 mm
4	CIB-EQP-001-004	*	4 mm
5	CIB-EQP-001-005	*	4 mm
6	CIB-EQP-001-006	*	4 mm
7	CIB-EQP-001-007	*	4 mm
8	CIB-EQP-001-008	*	4 mm
9	CIB-EQP-001-009	Ø 107 ± 0,5 mm	RED
10	CIB-EQP-001-010	Ø 107 ± 0,5 mm	WHITE
11	CIB-EQP-001-011	Ø 40 ± 1 mm	WHITE

- \* Dimensions as specified in the Technical Specification document CBI-R004.0, available to qualified suppliers.

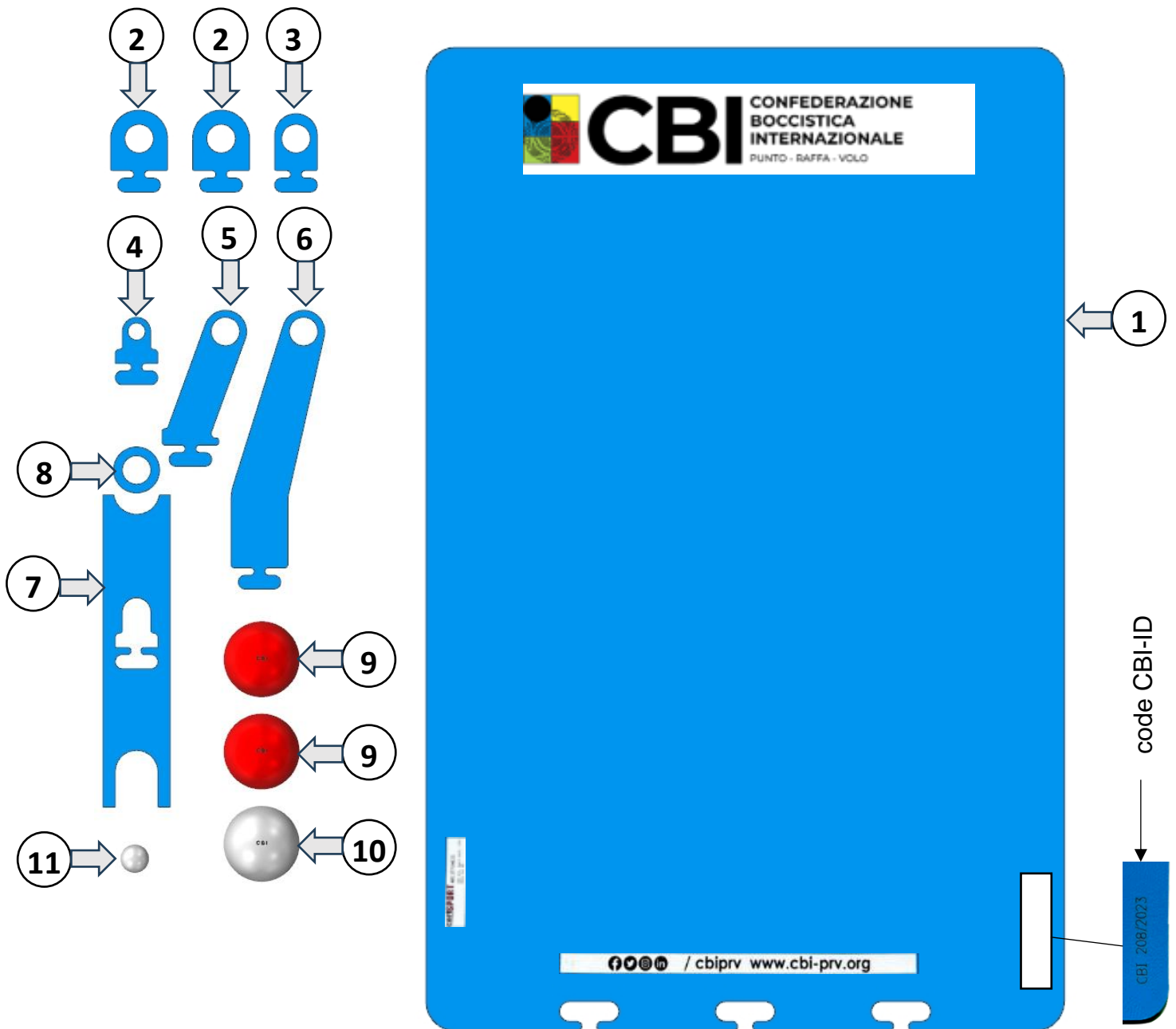

- b. The testing process for the official sets, required for the qualification of the manufacturer and therefore for the assignment of the CBI ID coding system (positioned as shown above), is carried out in accordance with Technical Specification CBI-R004.0 and recorded under the responsibility of the manufacturer, who must ensure full production traceability. Qualified suppliers must therefore maintain and make available to CBI, upon request, the list of official kits produced, including their serial numbers and the serial numbers delivered to the various customer.



## 6 GAME FORMATS AND SCORING

6.1 The discipline may be contested in the following formats:

- **Singles:** one male or female athlete against another. Each player has four bowls.
- **Doubles:** two male player compete againstvs two male players, or two female compete against two female players. Each player has four bowls.
- **Mixed Double (Team):** Two players (one male and one female) compete against another mix pair. Each player has four bowls.

6.2 This discipline is played on courts for male and female players, whose objective is to hit the targets indicated below. The targets are placed at 3 different distances and in 4 different positions for each distance, for a total of 12 targets with different point values. The goal is to score the highest possible number of points. If a players/teams successfully hits all 12 targets, achieving 40 points out of 40, the test continues starting again from target 1 in position 1.1 and ends at the first mistake.

6.3 As in the traditional discipline

- a. During the “Raffa” shoot, players must not let their front foot cross the “B” line before shooting the bowl; if they do it, the shoot is invalid.
- b. The bowl is only valid if it lands on the ground beyond line “D”; otherwise, the shoot is invalid.
- c. During the “Volo” shoot, players must not let their front foot cross the “C” line before shooting the bowl; if they do it, the shoot is invalid.
- d. Once the referee signals to proceed, the player has 30 second to complete the shoot.
- e. After the shoot, there is no obligation to stop within the line E , but the player must return to the “A–B” shooting area quickly so as not to hinder/disturb the shoot of the next player.

**6.4 Validity of the Throw**

a. The throw **is considered valid** if the TARGET is hit correctly and leaves its original position on the mat, even if it later returns to that position (for example, after gently rebounding off the OBSTACLE object).

However, the shoot is **invalid** if the “OBSTACLE” object leaves its original position on the mat at any time, even if it subsequently returns. If the OBSTACLE object moves but does not leave its original position, the throw remains **is valid**.

**MAT POSITION ON THE COURT**

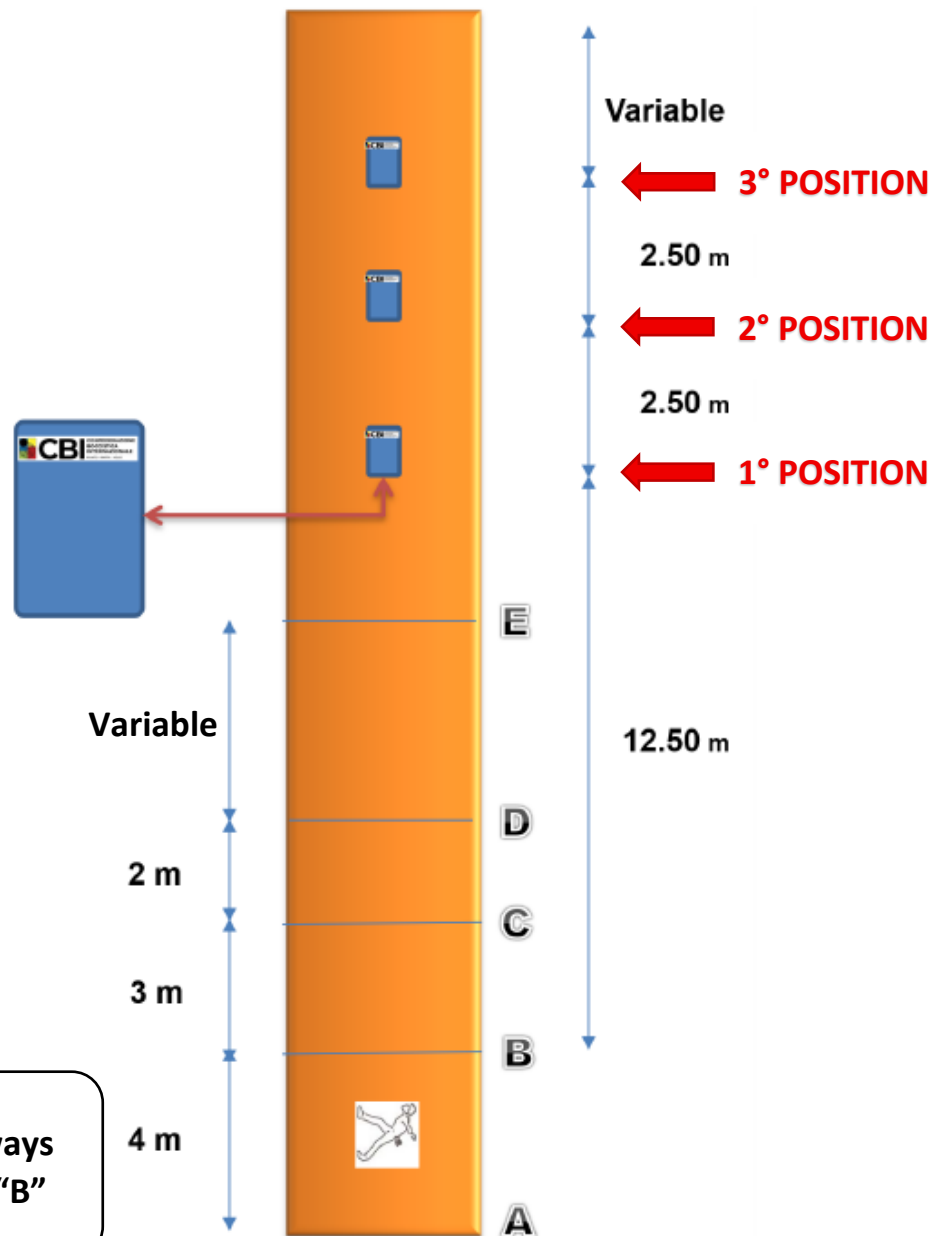

**The positions are always measured from line “B”**

**TARGETS IN 1° POSITION ON THE MAT**

1.1

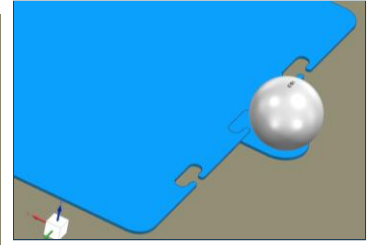
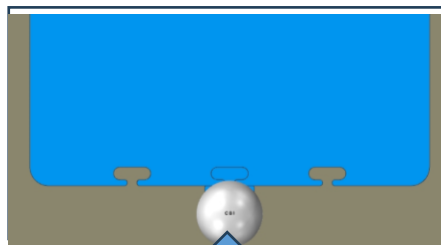
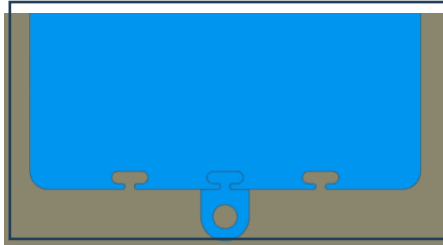

1st TARGET "WHITE BOWL"

1.2

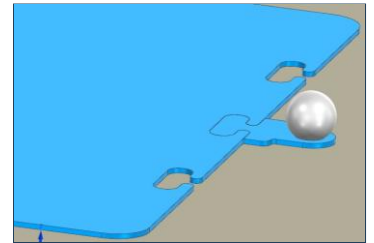
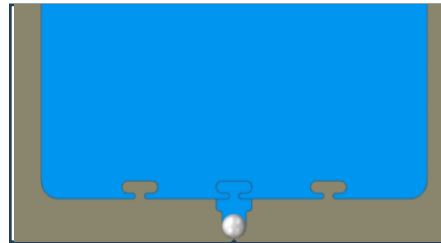
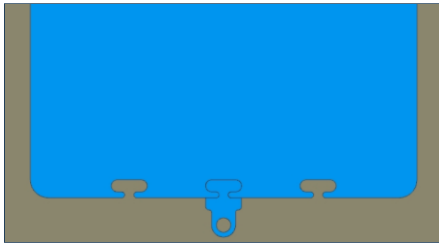

2nd TARGET "WHITE PALLINO"

1.3

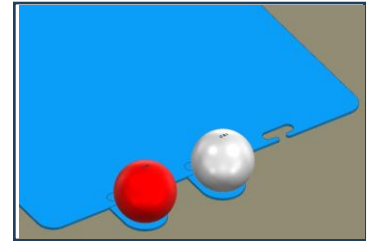
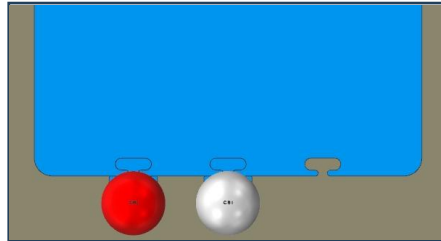
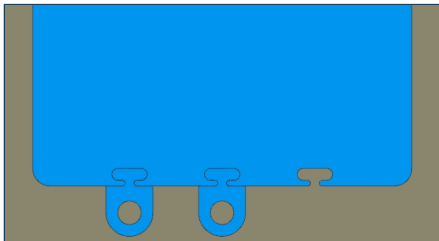

OBSTACLE "RED BOWL"

3rd TARGET "WHITE BOWL"

1.4

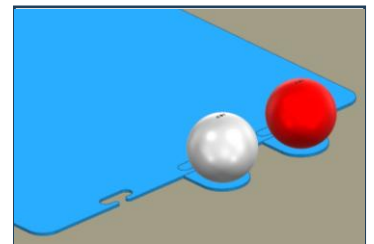
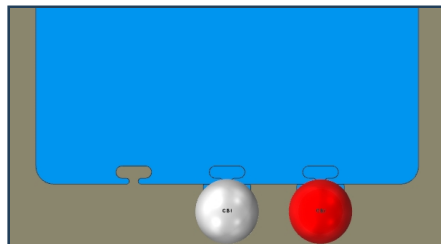
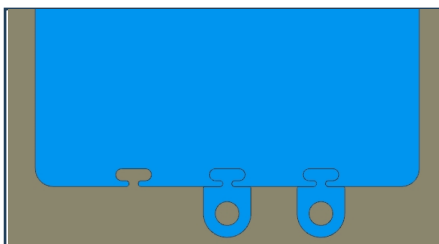

OBSTACLE "RED BOWL"

4th TARGET "WHITE BOWL"



**TARGETS 2° POSITION ON THE MAT**

2.1

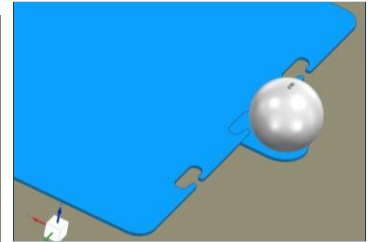
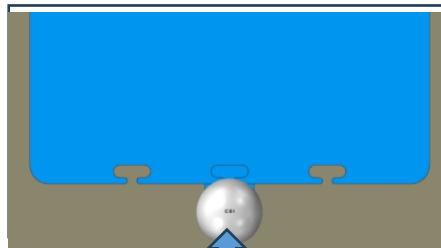
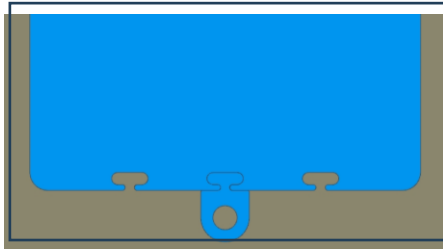

5th TARGET "WHITE BOWL"

2.2

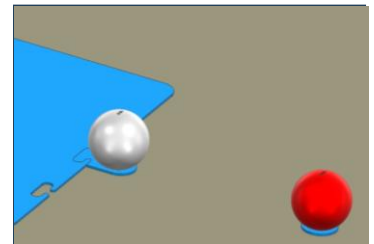
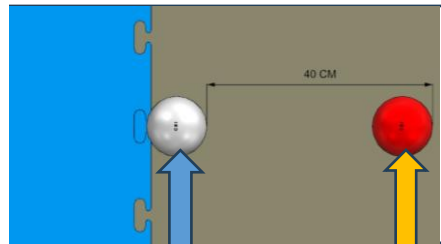
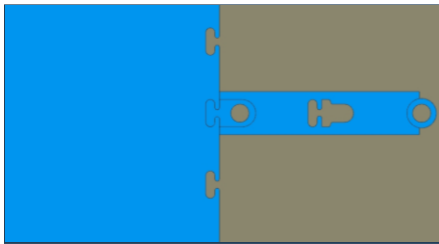

6th TARGET "WHITE BOWL"

OBSTACLE "RED BOWL"

2.3

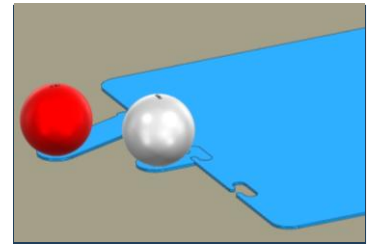
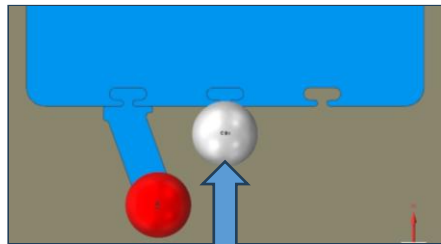
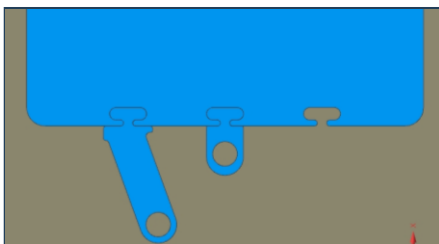

OBSTACLE "RED BOWL"

7th TARGET "WHITE BOWL"

2.4

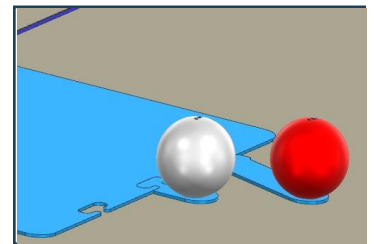
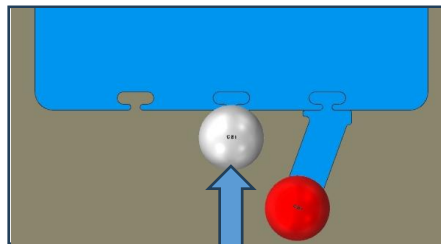
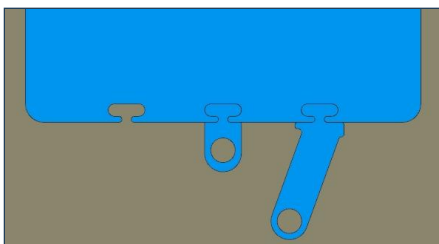

OBSTACLE "RED BOWL"

8th TARGET "WHITE BOWL"



**TARGETS 3° POSITION ON THE MAT**

3.1

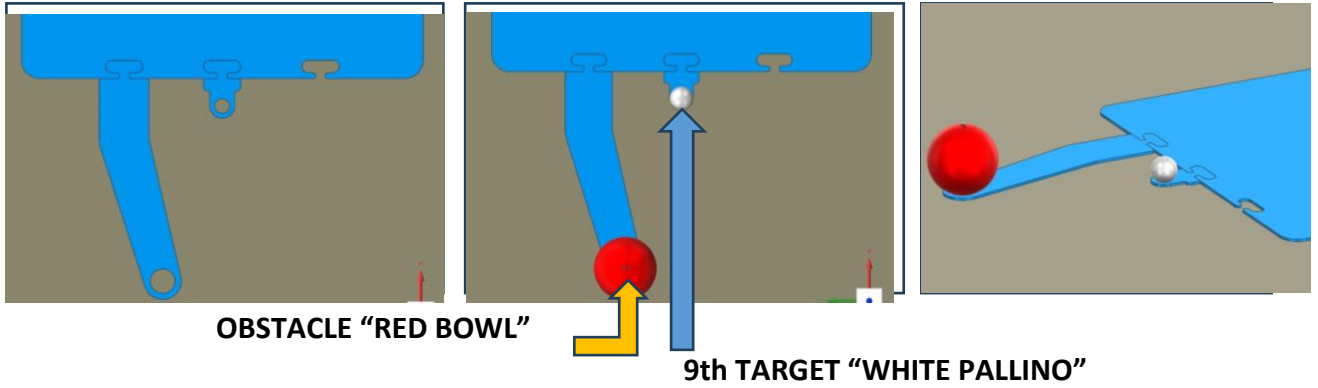

3.2

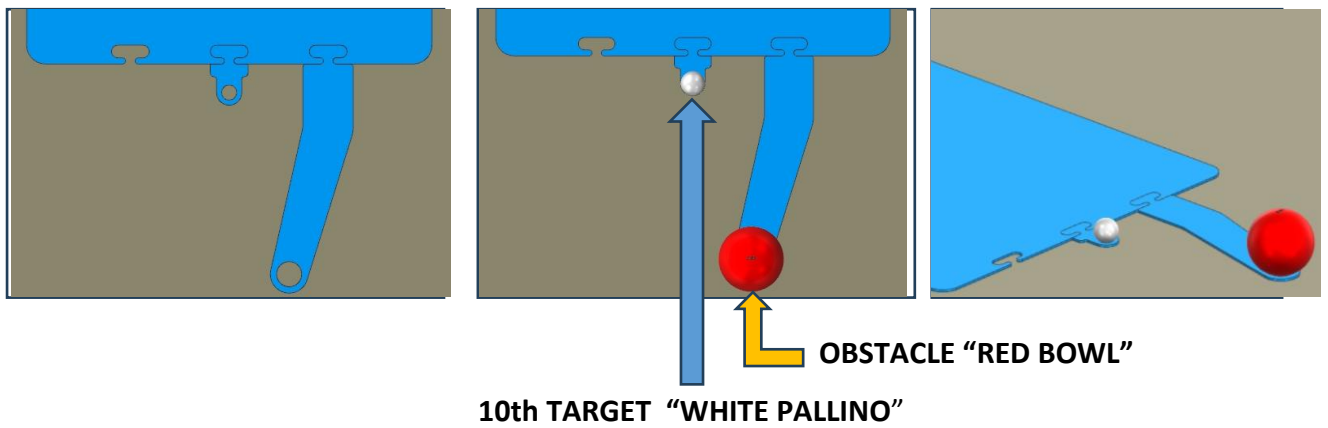

3.3

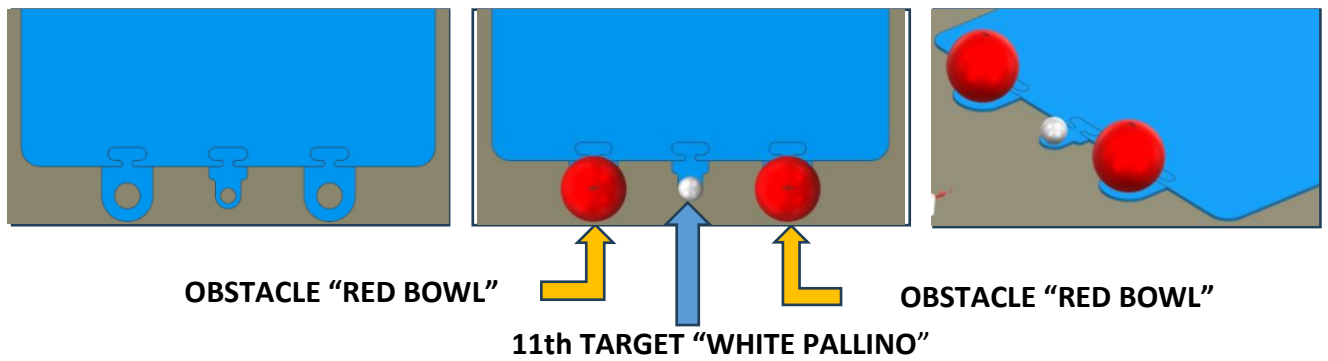

3.4

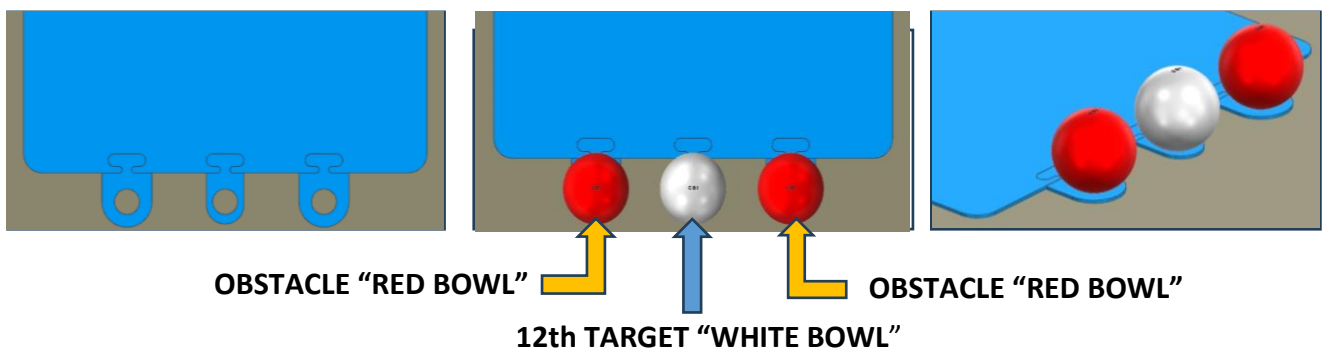

## 7 PROCEDURE FOR THE EXECUTION OF THE MATCH

### 7.1 WARM-UP SESSION

- a. The first athlete or team drawn in each pair of players (with a maximum number of pairs simultaneously not exceeding the number of available courts) shall proceed with a four-minute “free” warm-up. This warm-up performed individually by each player or team, with the freedom to choose which bowls or pallino target to hit. Coaches or team/nation staff members are responsible for preparing the targets and moving the MAT to the three designated positions. The same procedure shall be applied to the players drawn in any remaining pairs, in successive order.
- b. For groups composed of three or four players, upon completion of the “free” warm-up a series of three shoots per athlete (SINGLE) or 6 throws per teams (DOUBLES) shall be carried out, alternating attempts at the bowl positioned on the 1st target of the carpet (see image 1 below).

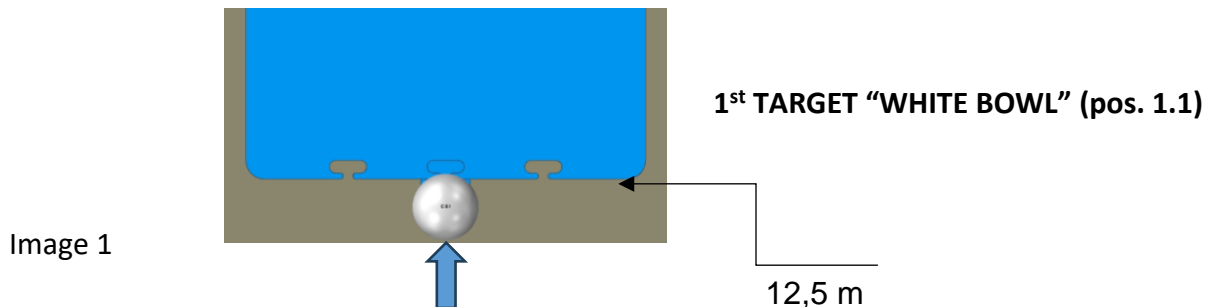

- c. If a subsequent match takes place within 30 minutes of the conclusion of a previous match involving which the player(s), the warm-up shall be conducted without a “free” warm-up. In this case, only one series of shoots shall be permitted: 4 shoots per player in SINGLE events or 8 shoots per team in DOUBLE events. Shoots shall be taken alternately at the bowl positioned on the first target of the mat (see image 1 above).



## **7.2 TEST PREPARATION**

At the end of warm-up, before starting the match, the referee manager will check that for every 2 courts in use, the referees are positioned as required (see image 2):

- a. Each court must be staffed with one referee in charge for positioning the targets and obstacles, and one assistant positioned at the end of the court to return the bowls after each position on the mat.
- b. For every two courts, there must be:
  - one linesman to check lines B and C
  - one linesman to check lines D
  - one supervisor referee responsible for verifying the validity of the shoot and recording the scores.
- c. Preparation of the first target on all lanes in use.
- d. Marking on the lane of the arc 40cm from the "TARGET" for the "VOLO" shot in order to verify the validity of the shot, to be performed on all targets.
- e. Providing a score sheet for each national manager or club manager, who has the right to record the scores during the match if they wish.

## MATCH SETUP SCHEME

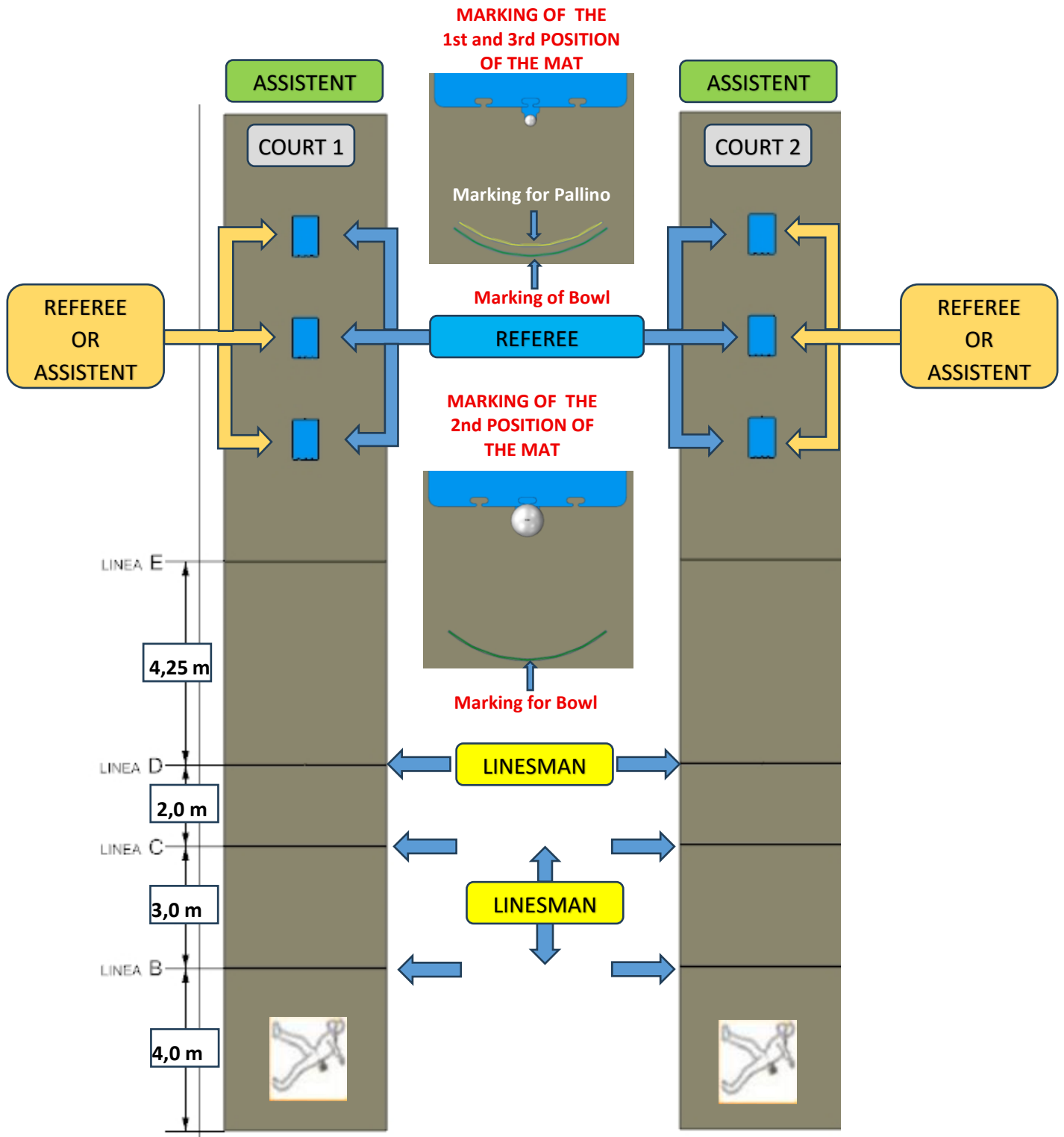

Image 2



### 7.3 MATCH

- a. The match begins with the presentation of the first player assigned to court 1, together with the indication of the target's point value.
- b. The players inform the referee of their preferred execution method, choosing between Raffa and Volo. The player must communicate to the mat referee their preferred execution "Raffa" or "Volo", using the following conventional gestures:
  - For the preferred execution of "Volo", the player must raise either their right or left arm; if they fail to do so, a "Raffa" shoot will be assumed.

The linesman then moves to line B for the Raffa shoot or to line C for the Volo shoot. The referee then gives the green light for the shoot and the shoot must be executed within 30 seconds. It is the player's responsibility to ensure that linesman has understood their preferred execution and is positioned on the correct line before executing the shoot. No protests can be made in such cases if the player fails to report any misunderstandings before the shoot.
  - **Instructions for SINGLES match:**
- c. The linesman positions himself according to the player's indication on the reference line (B for Raffa or C for Volo) and line D, identifying any irregular shoot by raising their arm or paddle.
- d. The referee raises their arm or paddle to signal any invalid shoot.
- e. Immediately after the first shoot, the official referee presents the first player of court 2 in the same manner. This player performs their shoot following the same procedure. The linesman and the referee monitor the shoot in the opposite court. This procedure is then repeated progressively in the subsequent courts until the first shoot of each first athlete has been completed. Players scheduled to shoot next must prepare accordingly.
- f. Progressively, only after the player in the next court has completed their shoots, any objects that may have been displaced are restored to their original position, provided that the shoots on the current target have not yet been completed.
- g. At the end of all players' shoots on the first target in their respective courts, the referee of each court shall prepares the second target. The procedure follows the same sequence as for the first target, then the third, and finally the fourth target on that mat position.
- h. Upon completion of the throws on all four targets for the first position on the court, the assistant in each lane shall return the balls to the athletes in an organized manner



- i. For the second and third positions of the mat, the procedure shall be carried out in the same manner as for the first position.

**Instructions for DOUBLES match:**

- j. The event begins with the introduction of a player from the first team in court 1, indicating the target's point value.
- k. Immediately after the first throw, the referee introduces the second player from the first team in court 1 in the same manner, who shoots with the same procedure as the first player.
- l. Immediately after the first shoot from the team in court 1, the referee introduces the first and then the second player from the team in court 2 in the same manner, who shoot with the same procedure as the players from court 1. The linesman and the mat referee follow the throw from the opposite court, and the same procedure is then repeated in the subsequent courts progressively until the first shoot is completed for each first team. The players in the order of the next shoot must prepare to shoot.
- m. Progressively, only after the players from the team in the next court have thrown, any objects that have been moved are returned to their position. Only when throws at the current target are completed does the referee then prepares the next target.
- n. Once all players in their respective court teams have finished shooting at the first target, the referee for each court must prepare the second target, and the procedure will be the same as for the first target, then the third, and finally the fourth target on the mat.
- o. Upon completion of the shoots at the four targets for each position on the mat, the assistant referee for each court will proceed to return the bowls to the players in an organized manner.
- p. For the second and third positions on the mat, the procedure will be the same as for the first position on the mat.

#### 7.4 OFFICIAL CONFIRMATION OF THE SCORES

To confirm and officially validate each player's score, the referee manager must receive from the referee(s) the score-recording sheet, signed by referee and by another referee assigned to the same courts to which the scores refer. The referee manager shall then wait for the team manager or coach at the referee-management table to compare the scores with those recorded by them and obtain their signature on the official confirmed-scores sheet

## 8 SUMMARY TABLE SCORE AND SCORE REGISTRATION SHEET

### 8.1 SUMMARY TABLE SCORE

THROW		TARGET	OBSTACLES	POINTS
ORDER	TARGET POSITION ON THE MAT			
1	1.1	WHITE BOWL		1
2	1.2	WHITE PALLINO		2
3	1.3	WHITE BOWL	NR°1 RED BOWL	3
4	1.4	WHITE BOWL	NR°1 RED BOWL	3
5	2.1	WHITE BOWL		1
6	2.2	WHITE BOWL	NR°1 RED BOWL	4
7	2.3	WHITE BOWL	NR°1 RED BOWL	3
8	2.4	WHITE BOWL	NR°1 RED BOWL	3
9	3.1	WHITE PALLINO	NR°1 RED BOWL	5
10	3.2	WHITE PALLINO	NR°1 RED BOWL	5
11	3.3	WHITE PALLINO	NR°2 RED BOWLS	4
12	3.4	WHITE BOWL	NR°2 RED BOWLS	6
			<b>TOTAL POINTS</b>	<b>40</b>

**8.2** If 2 or more players/teams correctly hits all 12 targets, achieving 40 points out of 40, they continue the match series by starting again from target 1 in position 1 and ends at the first error. A player may score more than 40 points as a result of the tie-break sequence, which is used when two or more players/teams finish the match with the same score. For Continental or World record to be valid it must consist of consecutive successful hits on the targets without errors,



**CBI** CONFEDERAZIONE  
BOCCISTICA  
INTERNAZIONALE  
PUNTO - RAFFA - VOLO

## INTERNATIONAL RULES

### DISCIPLINE: PRECISION SHOOTING

CBI-R001.1  
Rev. 1  
Approved on  
25 March 2026  
Page 21 / 31

and cannot include points obtained from the tie-break sequence if intermediate errors occurred during that phase.

### 8.3 MODULO REGISTRAZIONE PUNTEGGI

DATE

NAME OF THE MANIFESTATION

SCORE SHEET

Tournament  Male  Female

Group  1/4  1/2  Final

Athlete 1 Nation  First Name / Name

Athlete 2 Nation  First Name / Name

Athlete 3 Nation  First Name / Name

		Athlete or Nation					
<p>Manager</p> <p>First Name / Name <input type="text"/></p> <p>Signature <input type="text"/></p> <p>Referee 1</p> <p>First Name / Name <input type="text"/></p> <p>Signature <input type="text"/></p> <p>Referee 2</p> <p>First Name / Name <input type="text"/></p> <p>Signature <input type="text"/></p> <p>Played on carpet - CBI- / <input type="text"/></p> <p>Date: / / <input type="text"/></p>	3,4	6		<input type="text"/>	<input type="text"/>	<input type="text"/>	<input type="text"/>
	3,3	4		<input type="text"/>	<input type="text"/>	<input type="text"/>	<input type="text"/>
	3,2	5		<input type="text"/>	<input type="text"/>	<input type="text"/>	<input type="text"/>
	3,1	5		<input type="text"/>	<input type="text"/>	<input type="text"/>	<input type="text"/>
	2,4	3		<input type="text"/>	<input type="text"/>	<input type="text"/>	<input type="text"/>
	2,3	3		<input type="text"/>	<input type="text"/>	<input type="text"/>	<input type="text"/>
	2,2	4		<input type="text"/>	<input type="text"/>	<input type="text"/>	<input type="text"/>
	2,1	1		<input type="text"/>	<input type="text"/>	<input type="text"/>	<input type="text"/>
	1,4	3		<input type="text"/>	<input type="text"/>	<input type="text"/>	<input type="text"/>
	1,3	3		<input type="text"/>	<input type="text"/>	<input type="text"/>	<input type="text"/>
1,2	2		<input type="text"/>	<input type="text"/>	<input type="text"/>	<input type="text"/>	
1,1	1		<input type="text"/>	<input type="text"/>	<input type="text"/>	<input type="text"/>	
		Total		<input type="text"/>	<input type="text"/>	<input type="text"/>	<input type="text"/>

The coaches and the tournament director confirm with their signature that the above informations are correct.

## **9 QUALIFICATION AND RANKING PROCEDURE.**

### **9.1 SHOOTING ORDER**

For all championships or event under these regulations, the first-round shooting order is decided by the draw, and the second round follows the reverse order of the first round. Players are divided into groups of a maximum of 2 players. In cases of technical or organizational necessity, groups of 3 or 4 athletes may be formed (in World and Continental Championships only after a request and authorization from the Responsible Technical Commission).

In championships or events held in the pairs format, athletes are divided into groups of a maximum of 2 teams.

If in the first round Group 1 is composed of the following athletes:

- **A + B**, starting with A in groups of 2
- **A + B + C**, starting with A in groups of 3
- **A + B + C + D**, starting with A in groups of 4

In the second round Group 1 will be composed as follows:

- **B + A**, starting with B in groups of 2
- **C + B + A**, starting with C in groups of 3
- **D + C + B + A**, starting with C in groups of 4

### **9.2 1st QUALIFICATION ROUND**

1. The 1st qualification round is carried out according to the warm-up procedure described in Chapter 7.1.
2. It serves to determine **the 8 or 12 highest scores**, which will advance to the **2nd qualification round**.
3. It is conducted in 2 stages, each performing shots at 4 targets from each of the 3 positions on the mat (12 targets in total).
4. The scores from both stages will be added together for the purpose of qualification to the 2nd qualification round.
5. The nations or athletes with the **8 or 12 highest total scores** will advance to the 2nd qualification round the number of top scores to be considered will be determined by the Technical Refereeing Committee of the championship/competition, based on the participating nations or athletes and technical–logistical conditions.

## 6. Criteria for Qualification to the 2nd Qualification Round

- a. The nations/players with the 8 or 12 highest scores obtained in the 1st qualification round will advance to the 2nd qualification round.

## 7. Tie-Break Criteria (Score Equality)

- a. In the event of a tie in score, to determine qualification and/or establish the ranking order required for the subsequent rounds, the tie-break criterion shall be the highest (partial) score achieved in either of the two stages of the 1st qualification round.

Example

	<u>Score – 1st Stage</u>	<u>Score – 2nd Stage</u>	<u>Total Score</u>
Player/Nation A	12	<b>16</b>	28
Player/Nation B	14	14	28

- b. If the tie-break has been required for qualification to the 2nd round, and with reference to the example above, nation/player A qualifies based on the highest single (partial) score obtained in the 2nd stage.
- c. If the tie-break has been required to determine the ranking order, and with reference to the example above, nation/player A is placed ahead of nation/player B based on the highest single (partial) score obtained in the 2nd stage.
- d. In the event of a further tie, the players concerned shall compete in a third stage immediately after the last qualification stage, respecting any prescribed recovery times if necessary. This stage shall consist of repeating a full round (12 targets) on a common court (a lane on which all nations or players have shot), a neutral court (a lane on which no nation or players has shot), or a court assigned by draw.
- e. Before the third stage (tie-break), a draw is conducted to determine the shooting order, and a warm-up is carried out consisting of a series of 4 shots per player, or 8 shots per team, performed alternately at the bowls positioned on the 1st target of the mat (see Image 3 below).

Image 3

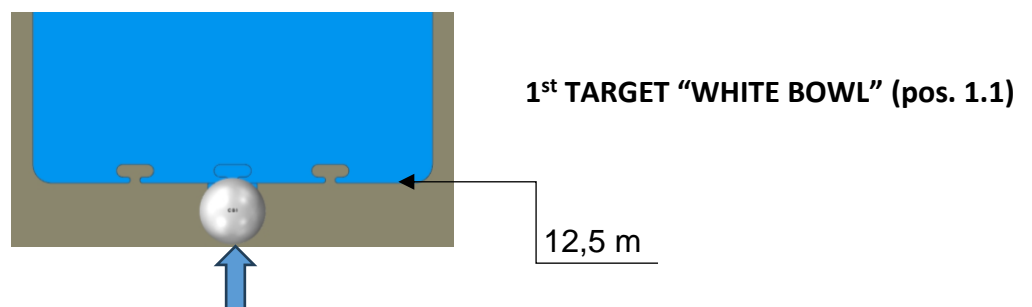

- f. In the event of a tie, the procedure continues starting again from Target 1 (mat position 1.1) and proceeds until the first situation in which a common target is validly hit by only one nation or player:
- If the tie-break involves **two nations or players**, it ends immediately, and the nation or athlete who hit the target advances to the next round or improves their ranking.
  - If the tie-break involves **more than two nations or players**, it does not end immediately but continues until qualification or ranking is progressively determined.

### 9.3 2nd QUALIFICATION ROUND

1. The **2nd qualification round** is carried out according to the warm-up procedure described in Chapter 7.1
2. It serves to determine the **4 highest scores**, which will advance to the **3rd qualification round**.
3. It is conducted in a single stage, with athletes performing shots at 4 targets from each of the 3 positions on the mat (12 targets in total).
4. The shooting order in the final is established in reverse order of the ranking from the 1st qualification round and according to the courts available

Example:

**on 4 lanes with 8 qualified nations or players, starting the shooting sequence from court 1**

<b>RANKING 1<sup>st</sup> QUALIFICATION ROUND</b>	<b>SHOOTING ORDER</b>	<b>LANE</b>
<b>1st</b>	<b>2nd</b>	<b>4</b>
<b>2nd</b>	<b>2nd</b>	<b>3</b>
<b>3rd</b>	<b>2nd</b>	<b>2</b>
<b>4th</b>	<b>2nd</b>	<b>1</b>
<b>5th</b>	<b>1st</b>	<b>4</b>
<b>6th</b>	<b>1st</b>	<b>3</b>
<b>7th</b>	<b>1st</b>	<b>2</b>
<b>8th</b>	<b>1st</b>	<b>1</b>



**5. Criteria for Qualification to the 3rd Qualification Round**

- a. The nations/players with the 4 highest scores obtained in the 2nd qualification round will advance to the 3rd qualification round.

**6. Tie-Break Criteria (Score Equality)**

- a. In the event of a tie in score, qualification and/or ranking order shall be determined using the higher-ranking position achieved in the 1st qualification round as the tie-break criterion.

**Example**

<b>Player/Nation</b>	<b>1st Round Ranking Position</b>
A	<b>3th</b>
B	6th

- b. If the tie-break has been required for qualification to the third round, Nation/Player A qualifies based on the better ranking position obtained in the 1st qualification round.
- c. If the tie-break has been required for to determine the final Ranking, Nation/Player A is placed ahead of Nation/Player B.
- d. This Tie-Break criterion also applies in the event of a tie involving more than two Nations or Players.

**9.4 3th QUALIFICATION ROUND**

1. The **3th qualification round** is carried out according to the warm-up procedure described in Chapter 7.1.
2. It serves to determine the **2 highest scores**, which will advance to **the Final**.
3. It is conducted in a single stage, with players performing shots at 4 targets from each of the 3 positions on the mat (12 targets in total).
4. The shooting order in the final is established in reverse order of the ranking from the 2nd qualification round and according to the courts available.

**Example:**

**on 4 courts  
with 4 qualified nations or athletes.**

**on 2 courts  
with 4 qualified nations or athletes**

3th QUALIFICATION ROUND	SHOOTING ORDER	LANE	3th QUALIFICATION ROUND	SHOOTING ORDER	LANE
1st	4th	4	1st	2nd	2
2nd	3rd	3	2nd	2nd	1
3rd	2nd	2	3rd	1st	2
4th	1st	1	4th	1st	1

**5. Criteria for Qualification to the Final**

- a. The nations/athletes with the two highest scores achieved in the third qualification round advance to the final.

**6. Tie-Break Criteria (Score Equality)**

- a. In the event of a tie, the tiebreak criterion is:
  - **the better ranking position obtained in 2th qualification round.**

**Example:**

Player/Nation	2nd Round Ranking Position
A	<b>2nd</b>
B	3th

- b. Therefore, Nation/Athlete A qualifies based on the better ranking position obtained in 2th qualification round.

**7. Determining the 3rd Place Ranking in the Event of a Tie**

- a. When the nations or athletes ranked 3rd and 4th achieve the same score, the final position is determined by applying the criterion specified in point 7b.
- b. To assign the 3rd place (bronze medal), the following criterion is applied:
  - the best performance achieved in the 2nd qualification round.



**Example:**

<b>Athlete/Nation</b>	<b>2nd Round Ranking Position</b>
A	1st
B	4th

- c. Therefore, Athlete A is ranked in 3rd place (is thus awarded the bronze medal when applicable), having achieved the better performance in the 2nd qualification round.

**9.5 FINAL**

- a. The final is carried out according to the warm-up procedure described in Chapter 7.1.
- b. Its serves to determine the winner(s) of the championship or event.
- c. It is conducted in a single stage, with athletes performing shots at 4 targets from each of the 3 positions on the mat (12 targets in total).
- d. In the event of a tie at the end of the round, the competition continues starting again from Target 1 (mat position 1.1) and proceeds until the first instance in which a common target is correctly hit by only one nation or player, which determines the conclusion of the final and the winner of the championship or event.

**10 ALTERNATIVE QUALIFICATION PROCEDURE AFTER THE 2 MATHES OF THE 1ST ROUND**

As an alternative to the above qualification procedures, and subject to approval by the CBI International Technical Commission and/or the CBI Board, the following system may be adopted for the post-qualification phase after the first round (2 stages) of competition.

This system shall consist of knockout format including quarterfinals, semifinals, and final. The nations or players will be paired according to the qualification ranking, following the designated competition grid.

The winner of each head-to-head match advances to the next phase. The bronze medal will be awarded to the athletes or nations defeated in the semifinals.

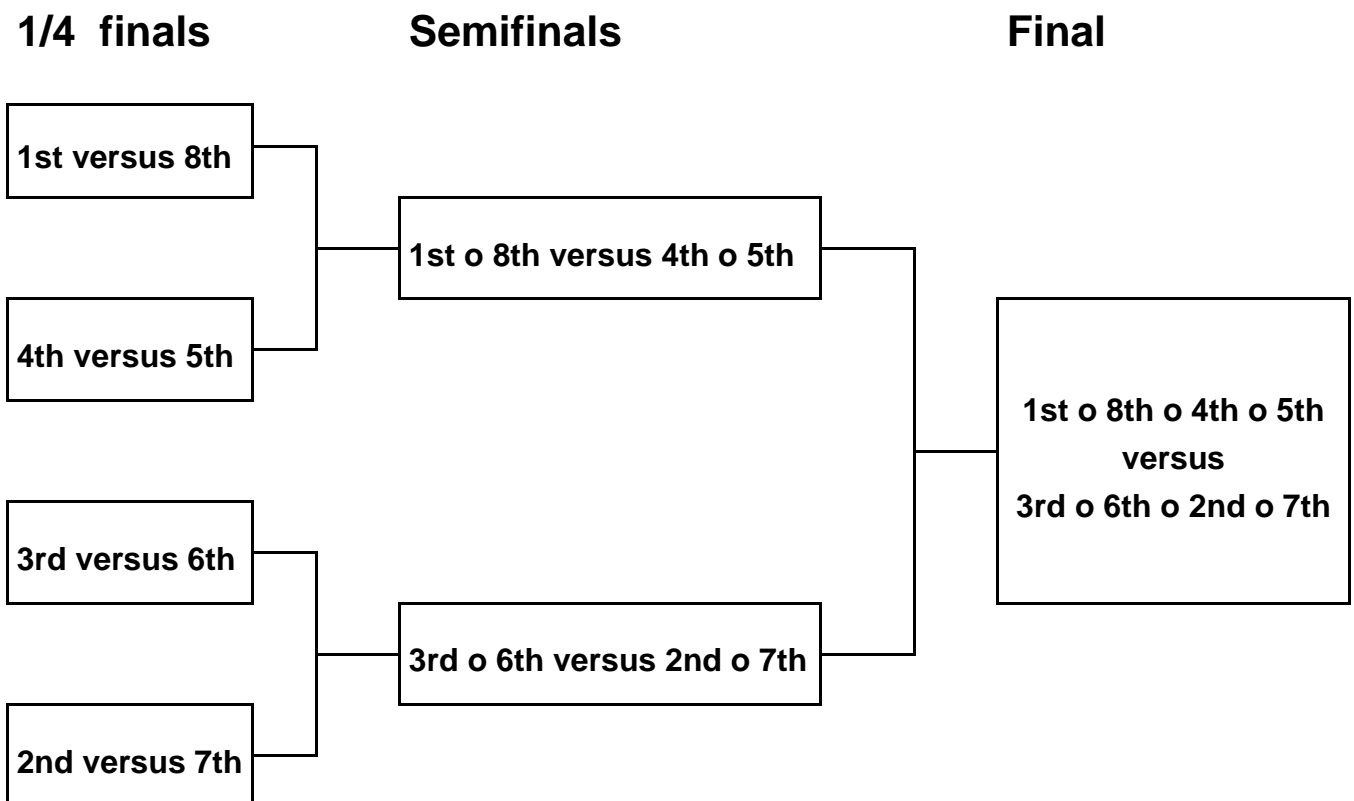

## 11 DECISION PROCEDURE

To ensure transparency and fairness in the management of competitions, the following decision-making hierarchy applies:

1. **Decision of the Referee** on technical actions during the game
2. **Intervention of the Referee Manager** in the event of a dispute
3. **Intervention of the Technical Delegate** if the dispute concerns regulatory or organizational aspects

## 12 SPECIFIC SITUATIONS

### **Breakage of a Bocce Ball or Pallino from the Official CBI Game Set**

If, during the test using a knockout format system, therefore with direct elimination, a bocce ball or the pallino belonging to the *Official CBI Game Set – Code CIB-EQP-001-0* breaks, and it is not possible to replace it with another certified piece from an identical set, the damaged piece shall be replaced with a non-certified element that is **as close as possible in size** to the original certified piece, **regardless of color**.

#### ➤ **Resumption of the Test**

- The test resumes from the **position of the mat** where the breakage occurred.
- **All players repeat the throw** if not all of them had yet taken their attempt at the designated target.
- If **all players had already thrown** at the designated target, the test continues with the **next target**.

#### ➤ **Record Validity**

Replacing a certified piece with a non-certified one results in the **non-ratification of any record** achieved during the test.

If the test is conducted using the standard points-sum system or the direct-score system, the test must be resumption exclusively with certified pieces.



### **13 CRITERIA AND PROCEDURES FOR THE RATIFICATION OF WORLD OR CONTINENTAL RECORDS**

- a. The ratification of International Records (Continental and World) is technically subject to the dimensions of the field on which the test is performed. As specified in Chapter 4, the width of the field must be between 3.50 m and 4.00 m; otherwise, the record cannot be ratified.
- b. The ratification procedure for International Records (Continental and World) with regard the technical management is governed by the document Identification No. CBI-P001.0.